

LA1224

LANYARDS

Material

Steel (1008), zinc plated.

Tips

For use in securing components to assemb-

lies, or to avoid items being misplaced. For a wide range of detent pins and quick release ball lock pins see parts 33010 through 33226. Terminals also available in

AISI 304 stainless steel on request. Subject to min. quantity.

Order No.	Material	Trade size	d_1	l_1 nom.	l_2
LA1224.M128-01-C	Steel	4	1.8	128	32
LA1224.M192-01-C	Steel	4	1.8	192	32
LA1224.M256-01-C	Steel	4	1.8	256	32
LA1224.M320-01-C	Steel	4	1.8	320	32
LA1224.M448-01-C	Steel	4	1.8	448	32



Sound Rigging Systems

Ball lock pins on a sound rigging system. Offering secure fixing with high shear forces and easy fitting for operators at heights.

In addition full black powder coating of grip and actuation button eliminates glare from other stage lighting.



Gym Equipment

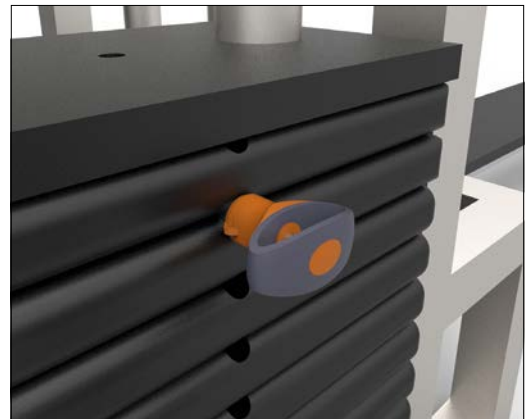

Scientific and Medical

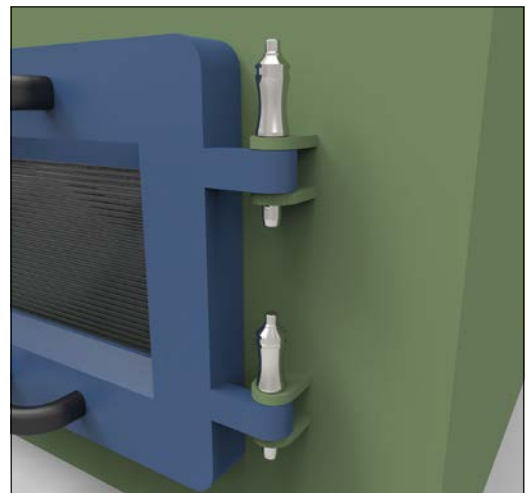
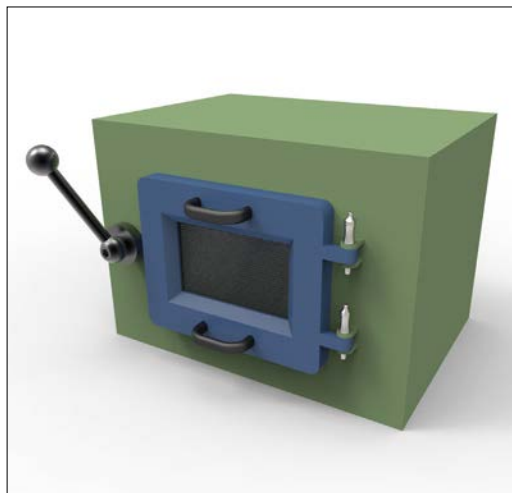



Wixroyd Ball Lock Pins

features

33060 - 33250

Positioning Elements

Pin Material

1.4305 (AISI 303) - shear force approx. 60% of higher material version 1.4542

1.4542 (AISI 630) - identified by the ridge on the pin

CRES 17-4PH (AMS 5643) aviation standard



Handle Style



Plastic tri-star

T-handled, metal

L-handled, metal

Mushroom, metal

Single piece metal, contoured



Special plastic self-spring

Adjustable grip length, plastic

Key ring

Safety, metal

Mushroom Type B aviation

Type R aviation

Lanyards and Locating Bushes

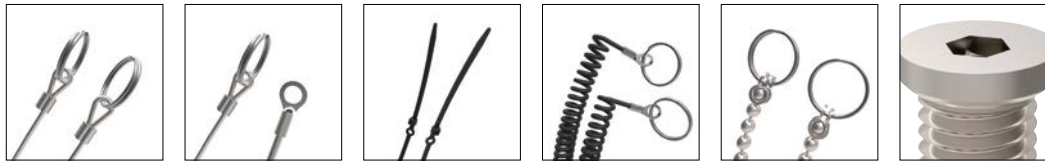

Stainless wire - (coated) - 2 x key ring

Stainless wire - Key ring and fixing loop

Plastic - 2 x cable tie

Steel wire - (coated) - 2 x key ring

Stainless bead chain - 2 x key ring

Locating bushes

Actuation



Press = unlock
Release = lock (standard)

Press = unlock and position
Release = lock and simultaneous clamp

Simple spring loaded balls "pullout pin"

Important Note

Important Note: Ball lock pins are not suited to lifting applications!
For quick release lifting pins, see part 33400.



Shear force

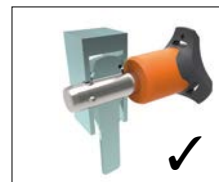

Lifting force

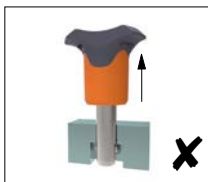

Special Variations



Variations on our standard designs are possible, please contact our sales team for technical assistance. Quick production on specials can be as little as 3 weeks.



Applications

- Positioning.
- Lifting.
- Locking.
- Indexing.
- Joining.

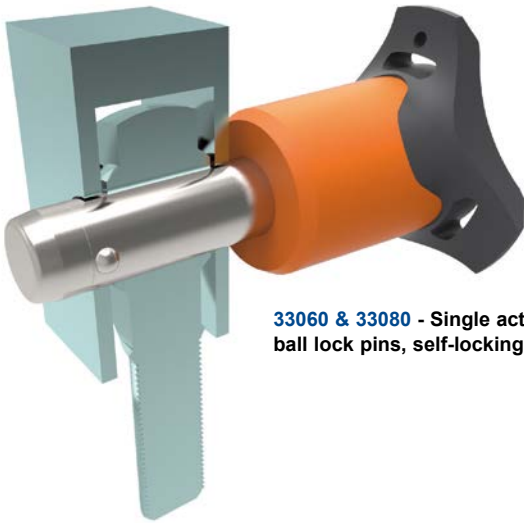

33060 & 33080 - Single acting ball lock pins, self-locking.



33194 - Single acting ball lock pins, self locking, simple finish.



33140 - Socket pins, non-locking, spring loaded balls.



33100 - Single acting ball lock pin, self locking.



33180 - Clamping pins, with span compensation, self-locking.



33250 & 33270 - Lanyards.



33220 - Ball lock pins, single acting - L-handle